



SUBARU

FORESTER





Welcome to a world of new possibilities.

Don't just see it-live it. With the 2024 Forester, you have enough comfort, safety and versatility for this adventure and the next one. Tough and compact on the outside, spacious and inviting on the inside, the Forester can help you find possibility just about everywhere.





Performance you can trust. Capability you can feel.

Balanced and stable around turns, even with its SUV height, the Forester is engineered to deliver confidence and outstanding ride comfort throughout your journey. With Subaru Symmetrical Full-Time All-Wheel Drive and X-MODE® standard on all trim levels, reassurance always comes with the terrain. And with the Forester Wilderness™, you can dare to venture even farther.

X-MODE® and Hill Descent Control

Take on almost any terrain with the traction-grabbing X-MODE® system featuring Hill Descent Control¹. For even greater adaptability, you can opt for dual-function X-MODE®², which includes two specifically designed settings—one for snow and dirt and one for deep snow and mud.

SI-DRIVE

Subaru Intelligent Drive (SI-DRIVE) lets you drive how you want, when you want. Select Intelligent Mode for balanced, smooth and environmentally friendly performance, or choose Sport Mode for an immediate and linear torque-rich throttle response for sporty and smooth driving at any speed³.



High Ground Clearance

The Forester is not only designed with high SUV ground clearance but also with careful consideration for approach, departure and breakover angles. All have been optimized to help you conquer obstacles without sustaining damage or getting stuck.



¹ Driver is always responsible for safe and attentive driving. Effectiveness of Hill Descent Control depends on many factors such as vehicle maintenance, weather, tire, and road conditions. ² Dual-function X-MODE® available on Sport, Wilderness, Limited and Premier trims only. ³ Sport sharp (S#) mode on Sport and Wilderness trims.



Comfort for all.

No matter the distance you travel in the Forester, comfort is always within reach. Its door openings have been specially designed to make getting in and out easy for everyone. Its spacious cabin offers conveniences, such as clever storage compartments and available centre console vents for the rear seats, and it's designed to reduce unwanted road noise and vibrations so you and your passengers can share quality time together on the road.



Centre Console Box

The centre console is large enough to store your electronic devices, such as small tablets. There's also a 12V power socket inside for your convenience.



Panoramic Power Sunroof¹

The available panoramic power sunroof's large opening provides a sense of spaciousness while leaving plenty of headroom for all passengers.



Convenient Seat Access

Seat height, side sill placement and door pillar design allow smooth, easy seat access for rear passengers.



Side Sill Steps

The rear side sill steps are wider and flatter with a slip-resistant surface for convenient roof rail use.







Feel connected, wherever you go.

Safely enjoy the convenience of smartphone connectivity while on the go, with standard Apple CarPlay^{®1} and Android[™] Auto². Designed with both advanced functionality and ease of use in mind, the Forester provides you with the latest infotainment functions and intuitive controls.



Apple CarPlay^{®1} and Android[™] Auto²

Seamlessly connect to your music and apps with Apple CarPlay^{®1} and Android[™] Auto². Voice recognition capabilities allow for hands-free use while reducing distractions when on the road.

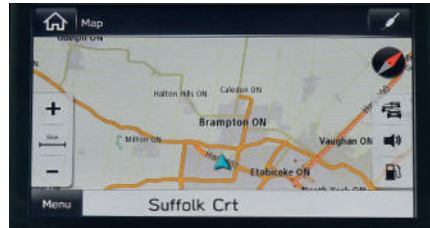

Navigation³

With sharp graphics and voice recognition, the available touchscreen navigation system, powered by TomTom^{®3,4}, makes it easy to find your next destination. Simply swipe, pinch and rotate the map as needed.



Multifunction Display

The available 6.3-inch LCD multifunction display provides useful information so you can keep your eyes on the road. When the available navigation system³ is in use, it shows turn-by-turn directions as you approach intersections or turns.



Meter Display

The standard full-colour LCD meter display keeps you informed about your drive and can easily be adjusted to meet your preferences.



Rearview Camera

When you shift into reverse, the camera displays a live colour image on the head unit display, along with guidelines to make parking easy. It also comes with a rearview camera washer to ensure a clear view.



Premium Audio System³ with Harman Kardon^{®5} Speakers

Featuring Harman Kardon[®]'s latest technology, GreenEdge^{®5}, the available premium audio system delivers rich, clear audio through nine speakers, including a subwoofer.

1 Apple CarPlay[®] is a registered trademark of Apple Inc.¹ 2 Android[™] is a trademark of Google LLC¹. 3 Limited and Premier trims only. 4 TomTom[®] is a registered trademark of TomTom International B.V. 5 Harman Kardon[®] and GreenEdge[®] are registered trademarks of Harman International Industries, Inc.



Plenty of space for all your memories.

An expanded cargo area, an easy-to-use power rear gate¹ and a cargo-area light are just some of the ways the Forester brings more convenience and versatility to daily life. It's ready to be part of what you love to do.



Access the cargo area with the touch of a button, even when your hands are full. The inner lock switch lets you conveniently close the rear gate and lock all doors at the same time.



An extra-wide rear gate opening makes it simple to load and unload your larger gear. The 60/40-split folding rear seats have been optimized for a flatter cargo floor, making it easier to carry longer items. Plus, the sides of the cargo area are made of a durable material that helps hide dirt and scratches, so you can fully enjoy the outdoors without worry.



The 12V power supply, rear-seat folding switch² and bag hooks are consolidated in the same area for ease of use. The cargo net hooks are installed in the four corners of the cargo area for convenient luggage net use.

¹ Available on Touring, Sport, Wilderness, Limited and Premier trims only. ² Wilderness, Limited and Premier trims only.



Subaru Wilderness™ badging



17-inch matte black alloy wheels with all-terrain tires



Anodized Copper-finish accents

The unpaved world is officially open.

The 2024 Forester Wilderness™

Nothing sounds too remote when you're in the Forester Wilderness. With its off-road-tuned gearing, dual-function X-MODE® and increased ground clearance, this Forester is designed to meet the demands of the terrain. That's why we increased its approach, departure and breakover angles, and why we gave it function and purpose inside and out—from its soft-touch all-weather upholstery to its 17-inch wheels with A/T tires. The Forester Wilderness also has wider roof rails with a greater roof load capacity, and it can tow up to 1360 kg¹ so you can bring all the gear you need into that unpaved world.



¹ Trailer brakes may be needed. Some safety features, including X-MODE®, Blind-Spot Detection and Rear Cross-Traffic Alert, may not function properly when towing. See your Subaru dealer for details.



An extra set of eyes every time you drive.

Every Forester includes standard EyeSight® Driver Assist Technology¹.

EyeSight® Driver Assist Technology gives you a virtual second pair of eyes on the road that can warn you of potential danger ahead and even intervene if necessary. And with the latest version of EyeSight, detection and avoidance capabilities have been enhanced, thanks to a wider camera angle and improved braking performance.



Pre-Collision Braking¹

A driver ahead unexpectedly hits the brakes or cuts you off. EyeSight® warns you, applies brakes and, at lower speeds, can even help you stop your Forester.



Lane Departure and Sway Warning¹

You accidentally drift to the edge of your lane and begin to cross into another. EyeSight® watches for lane markers and chimes to warn you.



Adaptive Cruise Control with Lane Centring Assist¹

This system can automatically keep you centred in your lane, safely behind the car in front of you—even in traffic and around curves.



Pre-Collision Throttle Management¹

Can reduce your engine power to help give you more time to react and to help minimize the possible impact force and frontal impact damage.

Subaru Core Technologies

There's a reason only a Subaru drives like a Subaru—our engineering. It's what you'll find at the core of our vehicles and what makes them safer, more capable and longer-lasting.



SUBARU BOXER® Engine

With a naturally balanced, compact design featuring pistons that move side to side, SUBARU BOXER® offers better stability and more durability than other engine types.

Subaru Symmetrical Full-Time All-Wheel Drive (AWD)

Subaru Symmetrical Full-Time AWD distributes power to all wheels for better traction on wet and slippery roads. Laid out in a horizontally symmetrical plane, this system has a well-balanced, low-centre-of-gravity design for a safer and more stable ride.

Lineartronic® CVT + Active Torque Split AWD

The Lineartronic® Continuously Variable Transmission (CVT) continuously adjusts to any ratio in its range for smooth and stepless operation for smoother acceleration and better fuel efficiency. It comes paired with Subaru's active torque split AWD system. Its default torque is well-balanced front to rear and adjusts in response to real-time traction conditions.

Subaru Global Platform

Enhancing all-around safety and performance, the Subaru Global Platform offers the driving feel you can find only in a Subaru, while also helping protect you and your passengers, thanks to its rigid construction.

More Fun to Drive

The Forester is designed to handle more like a car. Even with its high ground clearance, the Forester securely hugs the road around turns, resulting in an SUV that's safer and more fun to drive—even on long trips.

Ride Comfort

Improvements in chassis rigidity, suspension and stabilisers efficiently absorb shocks from the road and hide uneven surfaces.

1 EyeSight® is a driver assist technology, which may not operate optimally under all driving conditions. The driver is always responsible for safe and attentive driving. System effectiveness depends on many factors such as vehicle maintenance, weather and road conditions. The Pre-Collision Braking System is designed to provide automatic braking that either prevents a collision or reduces the severity of a frontal impact. Pre-Collision Throttle Management is designed to reduce acceleration and minimize the severity of certain frontal impacts. Lane Centring Assist is designed to assist the driver and is not a substitute for safe and attentive driving. Lane centring function operates only when used in conjunction with Adaptive Cruise Control. The Lane Departure and Sway Warning, and Lane Keep Assist operate only when the lane markings are visible, and its effectiveness depends on many factors. See Owner's Manual for complete details on system operation and limitations.

The road may waver but not your priorities.

Safety that meets the highest expectations.

We know what's most important to you when you drive, and that's why safety is at the top of our minds, too. With every Forester, innovative features and active safety systems come standard, including EyeSight® Driver Assist Technology and LED Steering Responsive Headlights with High Beam Assist, which are designed to maximize visibility and make nighttime driving safer for everyone on the road. And for those dangers you don't see coming, you're covered with the available Subaru Rear/Side Vehicle Detection system, featuring Blind-Spot Detection and Rear Cross-Traffic Alert^{1,2}.



Blind-Spot Detection

Using radar sensors, Blind-Spot Detection^{1,2} warns you with a visual indicator on your side mirror if it senses a vehicle in your blind spot. Another feature of this system, Lane Change Assist^{1,2}, alerts you with a flashing indicator on your side mirror if it senses a vehicle approaching at a higher speed in a neighbouring lane and you signal for a lane change.



Rear Cross-Traffic Alert

Rear Cross-Traffic Alert^{1,2} uses radar sensors to help warn you of traffic approaching from the side as you are backing up, utilizing a flashing visual indicator on your side mirror and rearview camera display as well as an audible warning.



Reverse Automatic Braking

Reverse Automatic Braking^{1,3} can detect objects directly behind your vehicle when backing up at a low speed and can help bring the Forester to a stop if it detects an object within its range and the brakes have yet to be applied. There's also the rearview camera to help you keep an eye out.

1 Availability varies by trim level. See your Subaru dealer for details. 2 Blind-Spot Detection, Lane Change Assist and Rear Cross-Traffic Alert are systems designed to assist the driver by monitoring the rear and side areas of the vehicle during a lane change or reversing and are not a substitute for safe and attentive driving. 3 The Reverse Automatic Braking System is not a substitute for safe and attentive driving. System effectiveness depends on many factors, such as vehicle maintenance, weather and road conditions. Always exercise caution and use vehicle mirrors and the rearview camera when backing up. See Owner's Manual for complete details on system operation and limitations. 4 Activation with subscription required. 5 EyeSight® is a driver assist technology, which may not operate optimally under all driving conditions. The driver is always responsible for safe and attentive driving. System effectiveness depends on many factors such as vehicle maintenance, weather and road conditions. The Pre-Collision Braking System is designed to provide automatic braking that either prevents a collision or reduces the



SUBARU STARLINK® Connected Services

The Forester features available SUBARU STARLINK® Connected Services^{1,4} technology, bringing you added safety, security and convenience. It can alert a first responder in an emergency, help police locate your vehicle if it's stolen and more. And to get you started, equipped models come with a free three-year SUBARU STARLINK® Connected Services subscription, which includes Advanced Automatic Collision Notification, Enhanced Roadside Assistance, SOS Emergency Assistance and customizable vehicle alerts. It's control when you want it and help when you need it.



DriverFocus® Distraction Mitigation System

Subaru is taking on one of the biggest issues in the automotive industry: distracted driving. The Forester features an award-winning state-of-the-art safety system that helps reduce distracted driving for both new and experienced drivers. Working with EyeSight® Driver Assist Technology⁵, DriverFocus®^{1,6} is like having an attentive co-pilot along for the ride, ready to give a helpful alert if a driver becomes distracted or drowsy.

severity of a frontal impact. Pre-Collision Throttle Management is designed to reduce acceleration and minimize the severity of certain frontal impacts. Lane Centring Assist is designed to assist the driver and is not a substitute for safe and attentive driving. Lane centring function operates only when used in conjunction with Adaptive Cruise Control. The Lane Departure and Sway Warning, and Lane Keep Assist operate only when the lane markings are visible, and its effectiveness depends on many factors. See Owner's Manual for complete details on system operation and limitations. ⁶ The DriverFocus® safety technology is a driver recognition system designed to alert the driver if their attention to the road wavers or if the driver's face appears to turn away. The driver is always responsible for safe and attentive driving. System effectiveness may be affected by articles of clothing worn on the head or face. See Owner's Manual for complete details on system operations and limitations.

2024 Forester | Features & Dimensions

Panoramic Power Sunroof¹



LED Steering Responsive Headlights with High Beam Assist



DriverFocus® Distraction Mitigation System²

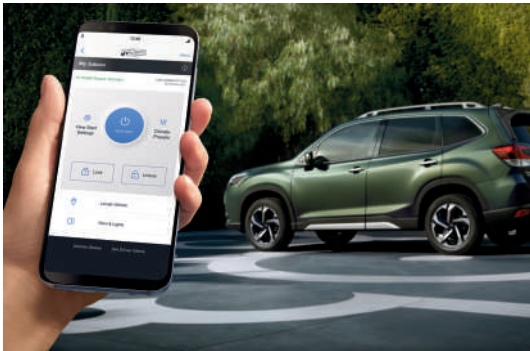

SUBARU STARLINK® Connected Services^{1,3}



Roof Rails



Heated Steering Wheel¹

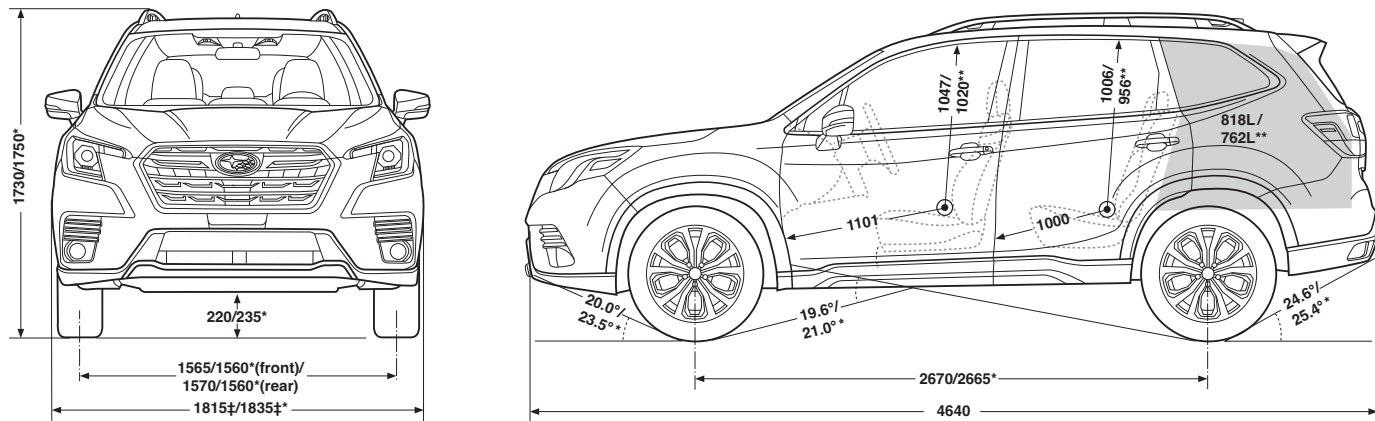

Measurements in millimetres

* Wilderness trim.

** With available sunroof.

‡ Excluding mirrors.

For a detailed list of specifications, features, accessories and model comparisons, please visit Subaru.ca or your nearest authorized Subaru Dealer.

1 Available on Touring, Sport, Wilderness, Limited and Premier trims. 2 The DriverFocus® Distraction Mitigation System is a driver recognition technology designed to alert drivers if their attention to the road wavers or if the driver's face appears to turn away. The driver is always responsible for safe and attentive driving. System effectiveness may be affected by articles of clothing worn on the head or face. See Owner's Manual for complete details on system operation and limitations. Limited and Premier trims only. 3 Activation with subscription required. 4 Apple CarPlay® is a registered trademark of Apple Inc. 5 Android™ is a trademark of Google LLC. 6 EyeSight® is a driver assist technology, which may not operate optimally under all driving conditions. The driver is always responsible for safe and attentive driving. System effectiveness depends on many factors such as vehicle maintenance, weather and road conditions. The Pre-Collision Braking System is designed to provide automatic braking that either prevents a collision or reduces the severity of a frontal impact. Pre-Collision Throttle Management is designed to reduce acceleration and minimize the severity of certain frontal impacts. Lane Centring Assist is designed to assist the driver and is not a substitute for safe and attentive driving. Lane centring function operates only when used in conjunction with Adaptive Cruise Control. The Lane Departure and Sway Warning, and Lane Keep Assist operate only when the lane markings are visible, and its effectiveness depends on many factors. See Owner's Manual for complete details on system operation and limitations. 7 This system is not a substitute for safe and attentive driving. System effectiveness depends on many factors, such as vehicle maintenance, weather and road conditions. Always exercise caution and use vehicle mirrors and the rearview camera when backing up. See Owner's Manual for complete details on system operation and limitations. 8 Blind-Spot Detection, Lane Change Assist and Rear Cross-Traffic Alert are systems designed to assist the driver by monitoring the rear and side areas of the vehicle during a lane change or reversing and are not a substitute for safe and attentive driving. 9 Yokohama® and Geolandar® are registered trademarks of Yokohama Tire Company. 10 Trailer brakes may be needed. Some safety features, including X-MODE® Blind-Spot Detection and Rear Cross-Traffic Alert, may not function properly when towing. See your Subaru dealer for details. 11 HomeLink® is a registered trademark of Genex Corporation. 12 Harman Kardon® is a registered trademark of Harman International Industries, Inc.

2024 Forester | Trim Levels



Forester

- 182-hp 2.5-litre 4-cylinder SUBARU BOXER® engine with direct injection
- Subaru Symmetrical Full-Time All-Wheel Drive with X-MODE® featuring Hill Descent Control
- Lineartronic® CVT (Continuously Variable Transmission) with Active Torque Vectoring
- SI-DRIVE Engine Performance Management and Auto Start-Stop
- 17-inch steel wheels with covers
- Wiper blade with integrated washer nozzle
- Rearview camera with washer
- LED Steering Responsive Headlights with High Beam Assist (HBA)
- Automatic climate control
- Cloth upholstery and heated front seats
- Rear seat and rear seatbelt reminders
- LED interior lights
- Roof rails with integrated tie-downs
- 6.5-inch infotainment system: Apple CarPlay®⁴, Android™ Auto⁵
- EyeSight® Driver Assist Technology⁶



Wilderness™

Includes Touring key features and adds/upgrades:

- 17-inch aluminum-alloy wheels with matte black finish and Yokohama®⁹ Geolandar®⁹ All-Terrain tires
- Dual-function X-MODE® with Hill Descent Control
- Lineartronic® CVT with off-road tuned gearing, SI-DRIVE with Sport Sharp (S#) mode and 1360 kg¹⁰ towing capacity
- Off-road tuned suspension with increased ground clearance
- Hexagonal LED fog lights
- Forester Wilderness-design front bumper and rear bumper underguard, fender flares and side cladding
- Forester Wilderness-design front grille
- Matte-black, anti-glare hood decal
- Subaru Wilderness badging on front doors and rear gate
- Black badging and window mouldings
- Higher-capacity roof rails
- Full-size spare tire
- Forester Wilderness soft-touch all-weather upholstery with Anodized Copper-finish accents and contrast stitching
- Forester Wilderness-design all-weather floor mats
- Forester Wilderness gauges with colour LCD display
- Front-view camera
- LED cargo and rear gate lights
- One-touch folding rear seatback
- Auto-dimming rearview mirror with compass and HomeLink®¹¹
- Auto-dimming side mirrors with approach lighting and LED integrated turn signals
- Black rear bumper step pad



Touring

Includes Forester key features and adds/upgrades:

- Lineartronic® CVT with manual-mode paddle shifters
- Roofline spoiler
- LED round fog lights
- 17-inch aluminum-alloy wheels
- Windshield wiper de-icer
- 6.3-inch colour multifunction display
- Premium cloth upholstery
- 10-way power-adjustable driver seat, including lumbar support
- Leather-wrapped heated steering wheel
- Dual-zone automatic climate control
- Rear-seat armrest with dual cupholders and reclining rear seat
- Cargo-area tray and tonneau cover
- SUBARU STARLINK® Connected Services³
- Proximity key with Push-button Start
- Reverse Automatic Braking (RAB)⁷
- Subaru Rear/Side Vehicle Detection (SRVD) with Blind-Spot Detection (BSD) and Rear Cross-Traffic Alert (RCTA)⁸
- Rear-seat A/C vents and dual rear USB ports
- Power rear gate
- Panoramic power sunroof
- 8-inch infotainment system: Apple CarPlay®⁴, Android™ Auto⁵ and 6 speakers



Limited

Includes Touring key features and adds/upgrades:

- Dual-function X-MODE® with Hill Descent Control
- 18-inch aluminum-alloy wheels
- DriverFocus® Distraction Mitigation System² with hand gesture control
- Two-position driver seat memory
- 8-way power-adjustable front-passenger seat
- Heated rear outboard seats and one-touch folding rear seatback
- Auto-dimming rearview mirror with compass and HomeLink®¹¹
- Auto-dimming side mirrors with approach lighting, LED integrated turn signals and passenger-side reverse tilt function
- Leather-trimmed upholstery and leather CVT shift boot
- LED cargo and rear gate light
- 8-inch infotainment system with navigation: Apple CarPlay®⁴, Android™ Auto⁵
- Harman Kardon®¹² 9-speaker audio system



Sport

Includes Touring key features and adds/upgrades:

- Dual-function X-MODE® with Hill Descent Control
- SI-DRIVE with Sport Sharp (S#) mode
- 18-inch dark grey-painted alloy wheels
- LED vertical fog lights
- Front, rear and side underguards with orange accents
- Orange and gloss black exterior accents
- Door mirrors with LED integrated turn signals
- Dark Grey sport fabric with leather shifter
- Orange stitching and interior trim accents
- Sport gauges with colour LCD display
- LED cargo and rear gate light



Premier

Includes Limited key features and adds/upgrades:

- Brown Leather-trimmed upholstery
- Exclusive 18-inch aluminum-alloy wheels
- Silver roof rails with integrated tie-downs
- Front, rear and side underguards with silver finish
- Gloss black window pillar trim
- Chrome front grille accents and fog light surrounds
- Satin chrome side mirrors and chrome door handles
- Stainless steel rear bumper step pad

2024 Forester | Colours

Exterior Colours



Crystal White Pearl



Ice Silver Metallic



Cascade Green Silica



Autumn Green Metallic



Geyser Blue



Horizon Blue Pearl



Magnetite Grey Metallic

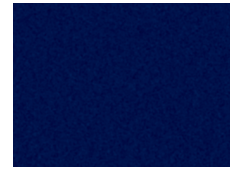

Sapphire Blue Pearl



Crystal Black Silica

Seat Material

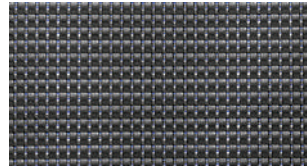

Black Cloth (BC)

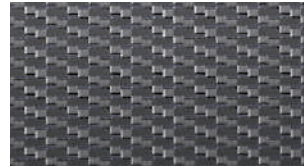

Black Premium Cloth (BPC)

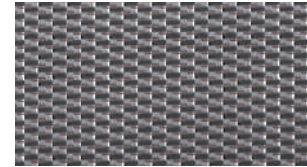

Dark Grey Sport Cloth (DGSC)



Wilderness™ Grey Soft-touch
All-weather Upholstery (GST)

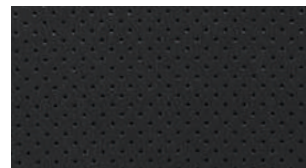

Black Leather (BL)

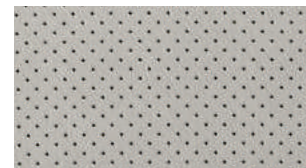

Platinum Leather (PL)

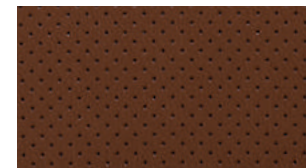

Brown Leather (BRL)

Colour Combinations	Forester	Touring	Sport	Wilderness	Limited	Premier
Crystal White Pearl	BC	BPC	DGSC	GST	BL	BRL
Ice Silver Metallic	–	BPC	–	–	BL	–
Cascade Green Silica	–	BPC	–	–	BL	BRL
Horizon Blue Pearl	BC	BPC	–	–	BL or PL	BRL
Magnetite Grey Metallic	BC	BPC	DGSC	GST	BL	BRL
Sapphire Blue Pearl	–	–	DGSC	–	–	–
Crystal Black Silica	BC	BPC	DGSC	GST	BL	BRL
Autumn Green Metallic	–	–	–	GST	–	–
Geyser Blue	–	–	–	GST	–	–



Subaru Warranties

Every Subaru vehicle is designed and built to offer our customers the highest possible level of quality and reliability. We are proud of our vehicles and proud to stand behind them with a comprehensive warranty. For 2024 model-year vehicles, the warranty on all Subaru vehicles consists of the following:

New Vehicle Limited Warranty (36 month/60,000 km) – Covers basic and major components for 36 months or 60,000 km.

Major Component Limited Warranty (60 month/100,000 km) – Extends coverage of major components (more than just powertrain) up to 60 months or 100,000 km.

Surface Corrosion Limited Warranty (36 month/60,000 km) – Covers surface corrosion to visible painted body panels for 36 months or 60,000 km.

Anti-Perforation Limited Warranty (60 month/unlimited km) – Covers perforation due to corrosion to body sheet metal panels for 60 months, regardless of kilometres.

Emission Control System Limited Warranty – Covers some emissions components for 36 months or 60,000 km and the major parts of the emission control system for 96 months or 130,000 km.

Parts and Accessories Limited Warranty – Covers Subaru parts and accessories installed by the Subaru dealer prior to retail delivery of the vehicle for 36 months or 60,000 km, and Subaru parts and accessories installed by the Subaru dealer after the retail delivery of the vehicle for 12 months or 20,000 km from the date of the installation.

The above information is an overview of warranty coverage and is not a warranty statement. If you wish to see more details regarding Subaru warranties, please refer to your Subaru warranty booklet, contact your local Subaru dealer or visit our Web site at subaru.ca.

Subaru 360 C.A.R.E. Program (36 months/unlimited km)

Access to dedicated Subaru 360 C.A.R.E. (Customer Assistance for Roadside Emergencies) Roadside Assistance Services, which includes access to 1,000 CAA and AAA offices throughout Canada and the United States. In addition to towing, coverage also includes Fuel Delivery, Battery Boost, Flat Tire Service, Lock-Out Service, Trip Accident & Mechanical Breakdown Assistance Service, Winching and Extrication Service, Personalized Trip Planning and Routing, Theft and Hit-and-Run Reward, and Arrest Bond Certificate.

The above information is an overview of services. If you wish to see more details regarding Subaru 360 C.A.R.E., please visit our Web site at subaru.ca.

Subaru Protection Plan

As a Subaru owner, you have expectations for a pleasurable, trouble-free ownership experience – now and into the future. Once your 36-month/60,000-km New Vehicle Limited Warranty period ends¹, our Subaru Protection Plan (SPP) – the only vehicle service contract endorsed by Subaru Canada for Subaru vehicles – can prolong your hassle-free ownership experience with three levels of extended service contract coverage tailored to your needs: Powertrain Protection; Major Protection; or Complete Protection (best level of coverage to complement the 60-month/100,000-km Major Component Limited Warranty). SPP offers comprehensive mechanical and electrical coverage and a number of additional features and benefits, such as Roadside Assistance and Alternate Transportation, for up to 7 years or 160,000 kilometres from your vehicle's in-service date. Whether your vehicle is purchased or leased, SPP protects you and your investment. Be sure to ask your Subaru dealer for details or visit subaru.ca.

¹ If you already own a Subaru vehicle and it is still within the 36-month/60,000-km New Vehicle Limited Warranty period, you are still eligible for SPP.

Subaru vehicles are uniquely designed to get out there more and to leave less behind. We build our vehicles for maximum longevity, because more time spent on the road equals less time spent in junkyards and landfills. In fact, 96% of Subaru vehicles sold in Canada over the last 10 years are still on the road today¹. You'll also find very little waste created in the production of a Subaru. Many of our vehicles are built in the Subaru of Indiana Automotive, Inc., (SIA) factory, which was the first manufacturing facility in the U.S. to achieve zero-landfill status. Other Subaru facilities around the world now achieve similar goals in helping to preserve the environment. Respect for our surroundings is yet another way that Subaru vehicles help to build driver confidence for the road ahead.

¹ Based on IHS Markit Vehicles in Operation as of June 30, 2022, for Model Years 2013 to 2022 vs. Total New Registrations of those vehicles.



For a detailed list of specifications, features, accessories, and model comparisons, please visit Subaru.ca or your nearest authorized Subaru Dealer.

The Supplemental Restraint System (SRS airbags) affords the driver and passenger additional protection in some collisions. This system provides supplemental protection only, and seatbelts must be worn in order to avoid injuries to out-of-position occupants upon airbag deployment. The combination of SRS and seatbelts provides the best protection in a serious accident. All illustrations, specifications, features and photographs contained in this brochure are based on product information available at the time of its printing and may not be completely accurate following its publication. For the most up-to-date and detailed product information, log on to www.subaru.ca. Colours shown may vary due to reproduction variations in the printing process, and some vehicle parts cannot be shown in certain photographs. Subaru Canada, Inc. reserves the right to discontinue or make changes at any time, without notice or incurring obligations, to colours, materials, equipment, accessories, features, specifications and models, or to change their prices. Some models shown may be from international markets and are not available in Canada; may be shown with equipment or accessories that are optional (at extra cost) or available only in certain combinations; or may be subject to product delays or not be available in Canada. Please visit subaru.ca for the latest information and specifications. For complete details on product updates and warranties, please contact your Subaru dealer. Ascent, BRZ, Crosstrek, Forester, Impreza, Legacy, Outback, Solterra, WRX, STI, DriverFocus, EyeSight, Lineartronic, X-MODE, STARLINK, Subaru and SUBARU BOXER are registered trademarks of SUBARU CORPORATION. Wilderness is a trademark of SUBARU CORPORATION. Android™ is a trademark of Google LLC¹. Apple CarPlay® is a registered trademark of Apple Inc.¹ Harman Kardon® and GreenEdge® are registered trademarks of Harman International Industries, Inc. HomeLink® is a registered trademark of Gentex Corporation. TomTom® is a registered trademark of TomTom International B.V. Yokohama® and Geolandar® are registered trademarks of Yokohama Tire Company.

† Ability of this product to access connected content is subject to change without notice and could be affected by any of the following: compatibility issues with future firmware versions of the smartphone; compatibility issues with future versions of the connected content application(s) for the smartphone; changes to or discontinuation of the connected content application(s) or service by its provider.

Printed in Canada. © 2023 Subaru Canada, Inc. 2024 model year.



Environmental Management System
(EMS) ISO 14001:2015 certified by SGS

This brochure was printed on certified paper and contains recycled fibre. It is chlorine-free, recyclable and biodegradable. It was produced using a "Green Printing Process" which includes vegetable-based inks that make this brochure fully recyclable leaving no harmful residue. Please recycle.



PROCESS CERTIFIED FOR REDUCED
ENVIRONMENTAL IMPACT. NEW
SPECIFIC ATTRIBUTES EVALUATED.
UL.COM/EL
UL2891

subaru.ca

SUBARU CANADA, INC.

560 Suffolk Court, Mississauga, ON, L5R 4J7